

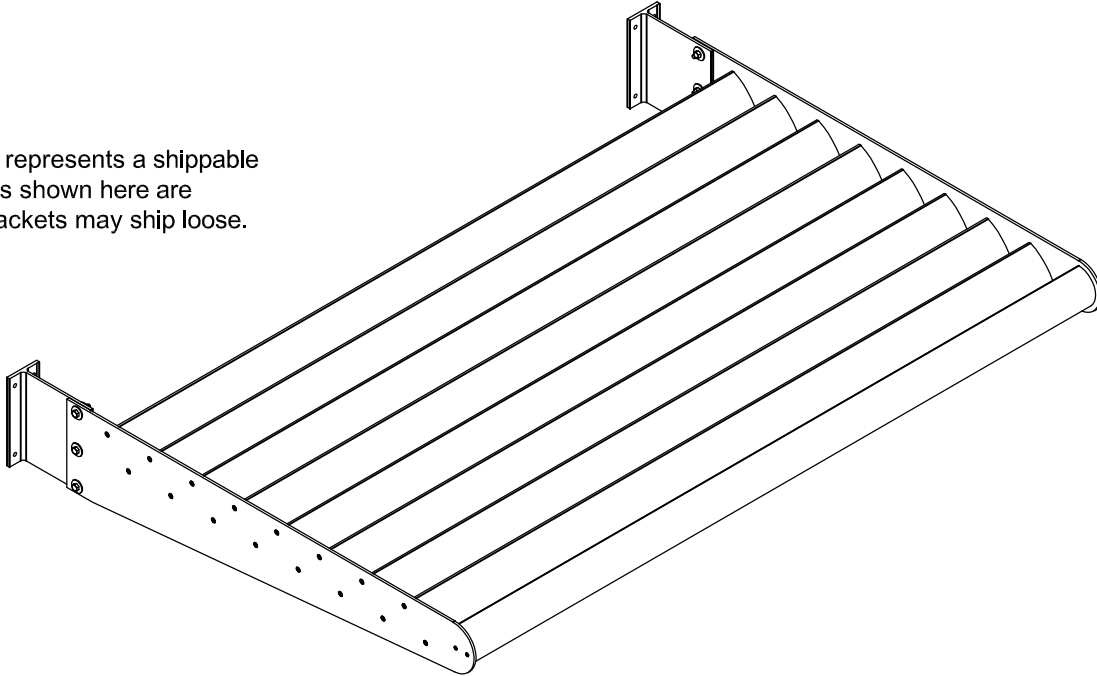

**Metal Distribution, Finishing and Fabrication**

**SAF Sun Control Systems  
Air Foil Configuration**

This drawing represents a shippable unit; fasteners shown here are included. Brackets may ship loose.



**SAF Sunshade: Options and Information**

RFQ Documents	Architectural Drawings, Structural Drawing Sheet S1, and PE Calculations, if available
Engineered Substrate	Structural Engineering for structures/mounting surfaces is the responsibility of others and is beyond the scope of the undertaking of SAF
Finishes	Anodized or PVDF Painted Finishes
Engineering	All SAF Sunshades must be engineered by a professional Engineer prior to fabrication and installation. Installation not by SAF.
General size Limitations	Anodize Finish - 36" depth from building face x 78" wide. *see note below Painted Finish - 48" depth from building face x 75" wide. *see note below
Required Maintenance	Minimal: Clean with low pressure water and mild detergents
Price	Ranges with complexity of the project
Installation Rating	Moderate
	* = Max sizes determined by Engineer

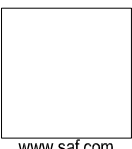
Customer:	Project:	 <a href="http://www.saf.com">www.saf.com</a>
Address:	Location:	
Phone / Fax:	Architect:	

**Product Support:**

SAF  
1581 Huber Street, N.W.  
Atlanta, GA 30318  
Telephone 404-355-1560  
Toll-free 800-241-7429  
Fax 404-350-0581

SAF Metal Fabrication  
14100 Veterans Memorial Hwy  
Villa Rica, GA 30180  
Telephone 770-942-1207  
Toll-free 800-241-7429  
Fax 770-942-4173

SAF Perimeter Systems Division  
14100 Veterans Memorial Hwy  
Villa Rica, GA 30180  
Toll-free 800-334-9823  
Fax 770-942-4173

SAF-West  
4356 Caterpillar Road  
Redding, California 96003  
Telephone 530-244-7518  
Toll-free 866-660-6627  
Fax 530-244-7830

SAF-Midwest  
5302 W. 78th Street  
Indianapolis, IN 46268  
Telephone 317-556-1890  
Toll-free 800-357-9016  
Fax 317-542-3031



# Metal Distribution, Finishing and Fabrication

## SAF Sun Control Systems Air Foil Configuration

### Outriggers:

- Fully Customizable: 1/4" Aluminum Plate, in 6061-T6 for painted finish and 6063-T5 for anodized finish

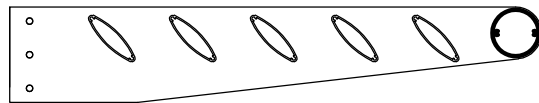
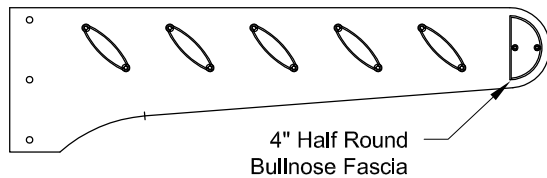
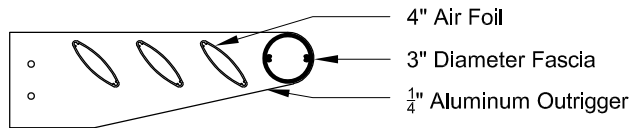

### Brackets:

- Available in lengths up to 11.625" from mounting surface.
- 6061-T6 customizable aluminum extrusions.

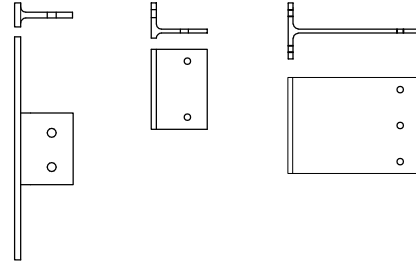

### Air Foils:

- Available in 4", 6", and 8".

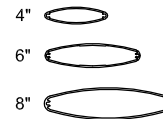

### Materials:

- Air Foils & Fascia - 6063-T6 Aluminum Alloy
- Brackets - 6061-T6 Aluminum Alloy
- Outriggers - 6063-T5 and 6061-T6 Aluminum Alloy - Restrictions apply

### Blade Configurations:

- Varies, based on desired amount of sun control and design
- Blade angles can be adjusted for different geographical locations

### Material Thickness:

- Air Foils & Fascia - .080" - .110" Thick Walls
- Brackets - .375" Thick Cap & Stem
- Outriggers - .25" Aluminum Plate

### System Configurations:

- Single Span
- Multiple Span

### System Dimensions:

- Up to a 48" depth and a 78" width for a single span sunshade - all systems require PE Stamp

### Options:

### Product Support:

SAF  
1581 Huber Street, N.W.  
Atlanta, GA 30318  
Telephone 404-355-1560  
Toll-free 800-241-7429  
Fax 404-350-0581

SAF Metal Fabrication  
14100 Veterans Memorial Hwy  
Villa Rica, GA 30180  
Telephone 770-942-1207  
Toll-free 800-241-7429  
Fax 770-942-4173

SAF Perimeter Systems Division  
14100 Veterans Memorial Hwy  
Villa Rica, GA 30180  
Toll-free 800-334-9823  
Fax 770-942-4173

SAF-West  
4356 Caterpillar Road  
Redding, California 96003  
Telephone 530-244-7518  
Toll-free 866-660-6627  
Fax 530-244-7830

SAF-Midwest  
5302 W. 78th Street  
Indianapolis, IN 46268  
Telephone 317-556-1890  
Toll-free 800-357-9016  
Fax 317-542-3031